

**4-FOOT SHOWCASE**

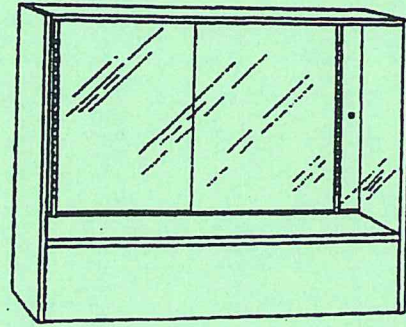

**5-FOOT SHOWCASE**

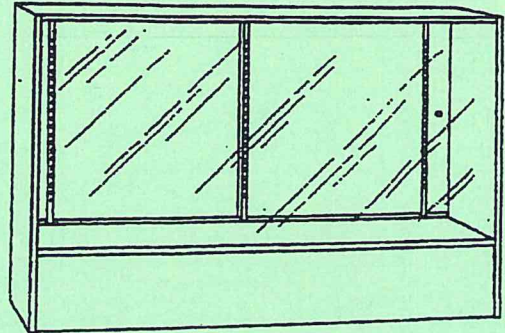

**6-FOOT SHOWCASE**

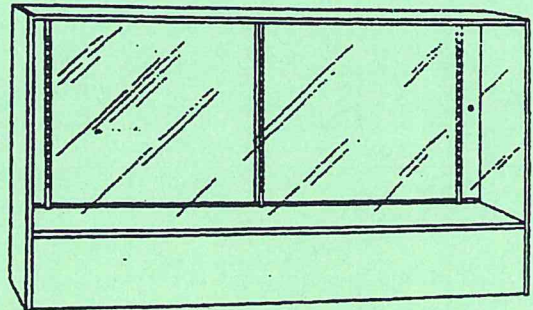

**NOTE:** It is recommended that two persons assemble this unit.

# **ASSEMBLY INSTRUCTIONS**



## PARTS LIST

PARTS & QUANTITIES SHOWN ARE FOR ONE COMPLETE SHOWCASE UNIT. GLASS PANELS, FELT STRIP AND PLASTIC GASKET NOT FURNISHED WITH THIS KIT.



(16)



(16)

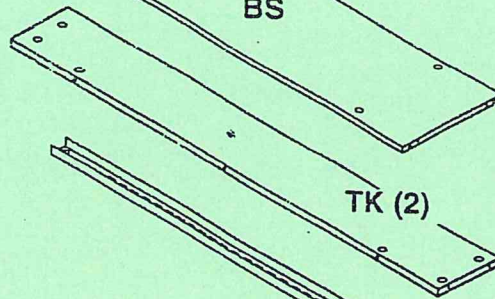
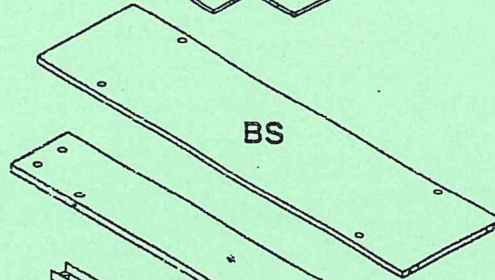
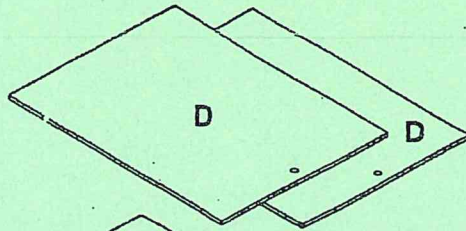

(2) For 4-ft. Showcase unit  
(3) For 5-ft. & 6-ft. Showcase unit

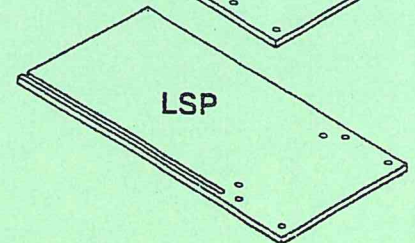
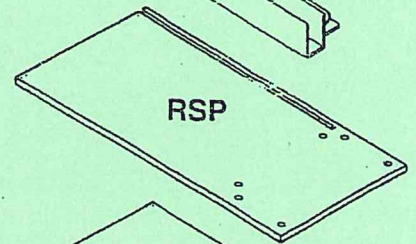
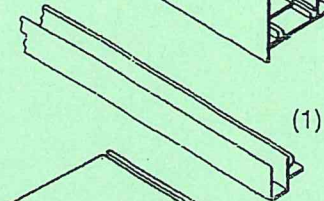
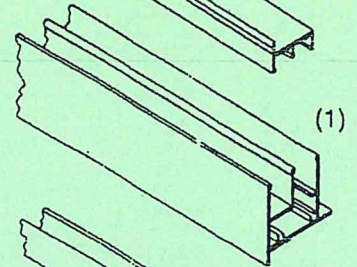
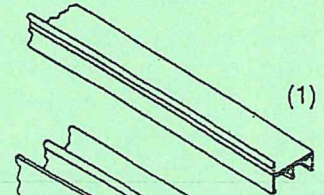

## TOOLS REQUIRED



1

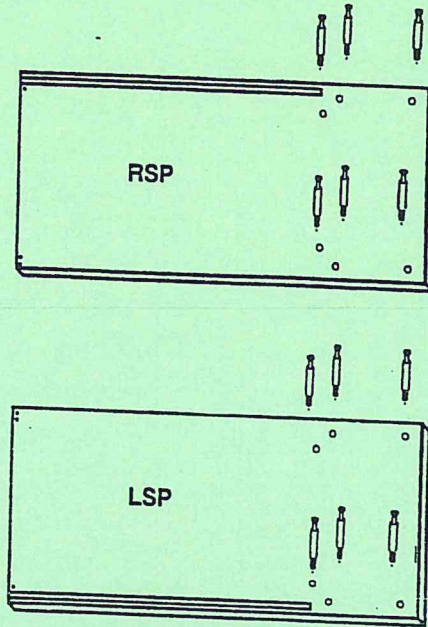

2

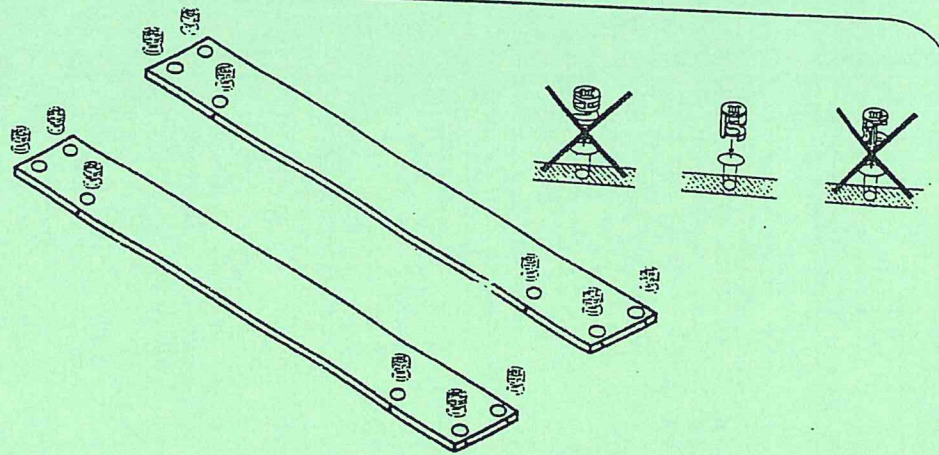



3

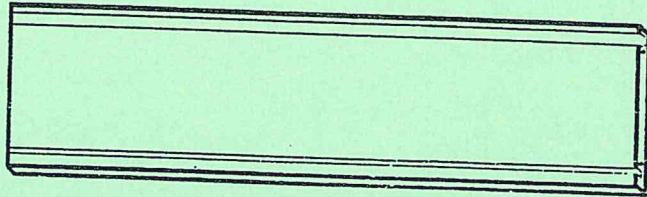
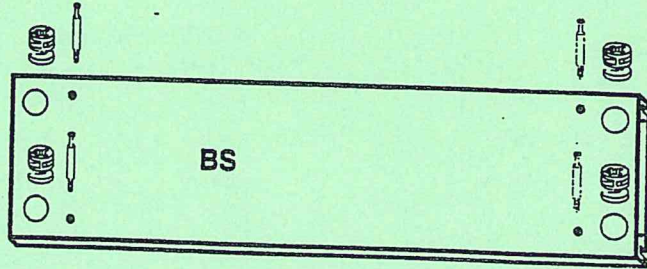

6mm groove

2mm groove

4

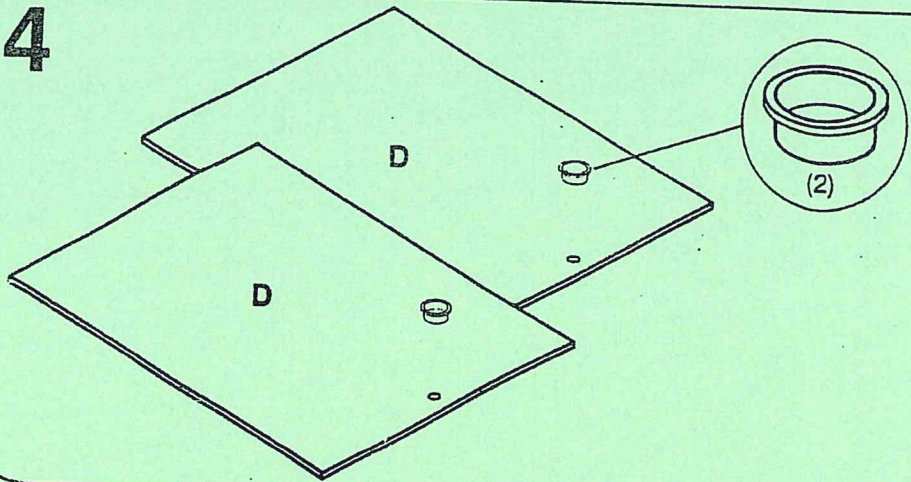

5

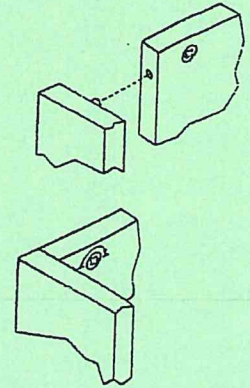
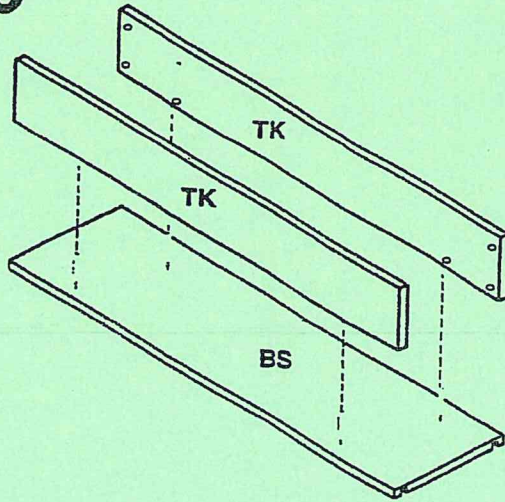

Fasten panels together and make sure all cams are locked.

6

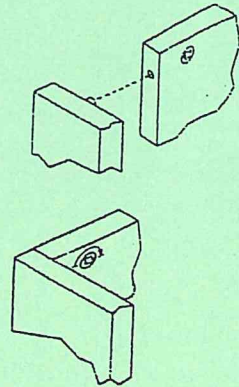
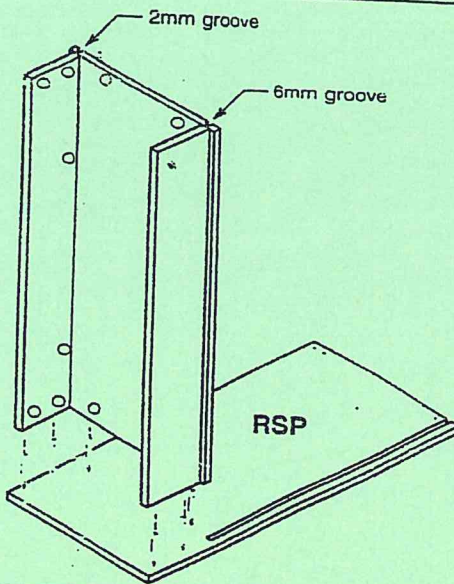

Fasten panels together and make sure all cams are locked.



7

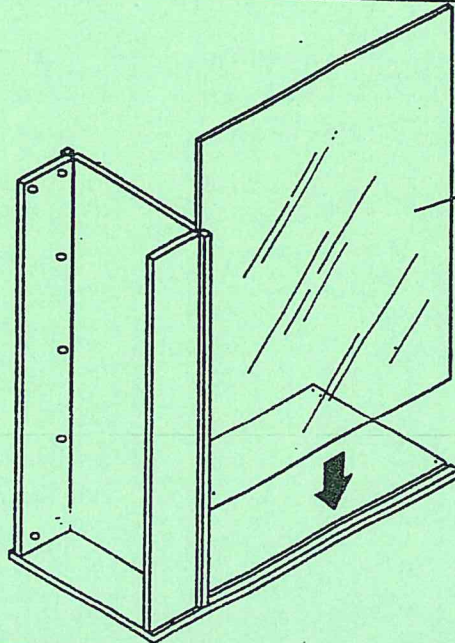

FRONT GLASS PANEL  
(Not furnished with kit.)

8

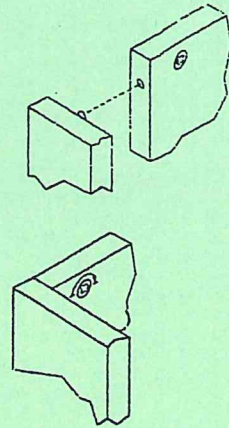
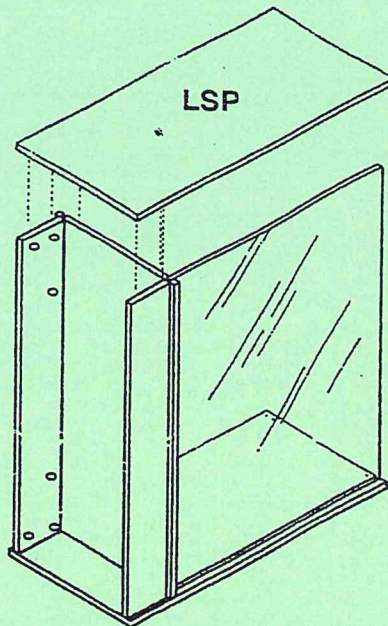

Fasten panels together and  
make sure all cams are locked.



9

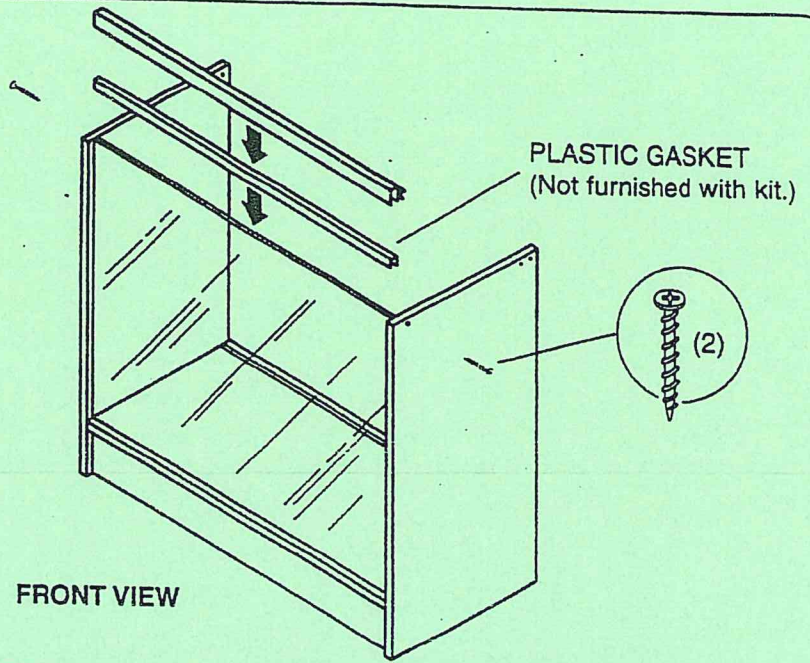

10

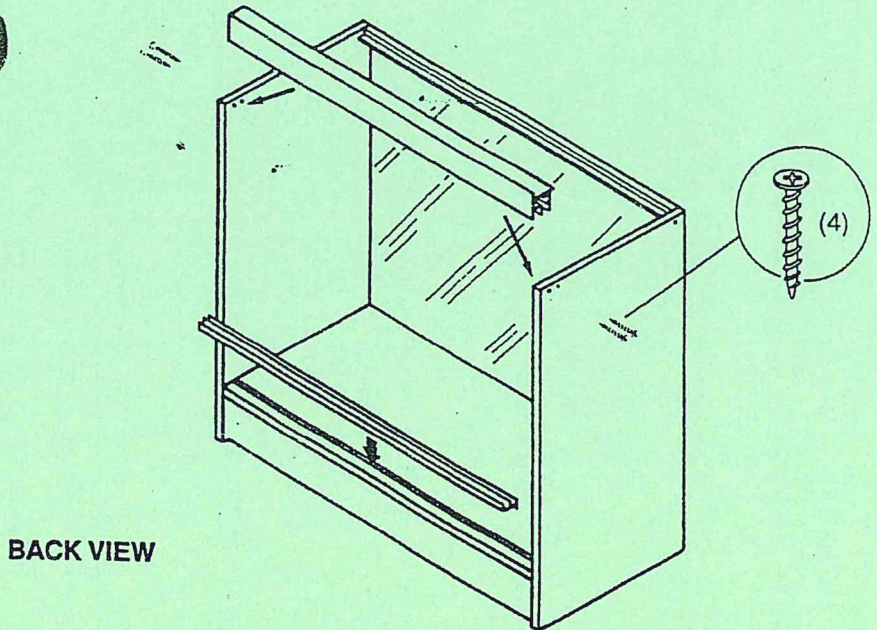



# 11

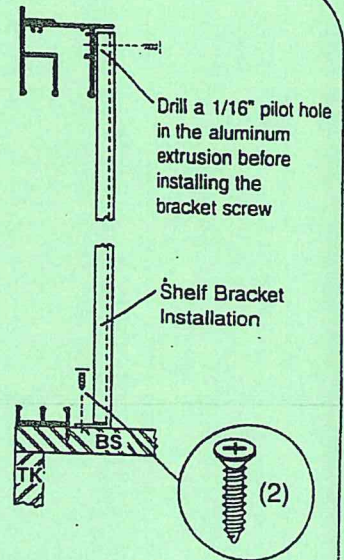
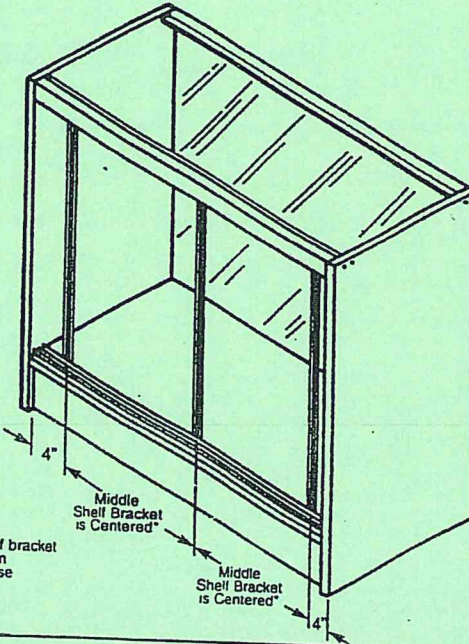

# 12

